



MAGNATM
Industrial Performance





MAGNA – Jakość i wydajność

Od kilkudziesięciu lat MAGNA – znana marka bitów do wkrętarek – cieszy się zaufaniem użytkowników profesjonalnych na całym świecie. Będąc wiodącym producentem bitów do wkrętarek dla wymagających użytkowników przemysłowych, MAGNA oferuje najwyższej jakości bity odznaczające się wysoką wydajnością i najwyższą trwałością. Nowoczesne metody produkcji gwarantują, że bity do wkrętarek MAGNA są wytwarzane z zachowaniem najwyższych standardów jakości.

Z myślą o użytkownikach

Dzięki optymalnym procesom produkcyjnym wszystkich typów bitów zaspokajamy potrzeby użytkowników i oferujemy produkty najwyższej jakości. MAGNA to zawsze właściwy wybór i pasujący bit do wszystkich konwencjonalnych wkrętów, o odpowiedniej jakości hartowania i odpowiednim napędzie.



Cztery typy bitów do wszystkich zastosowań

MAGNA oferuje szeroki program bitów do wkrętarek w czterech jakościach wykonania.

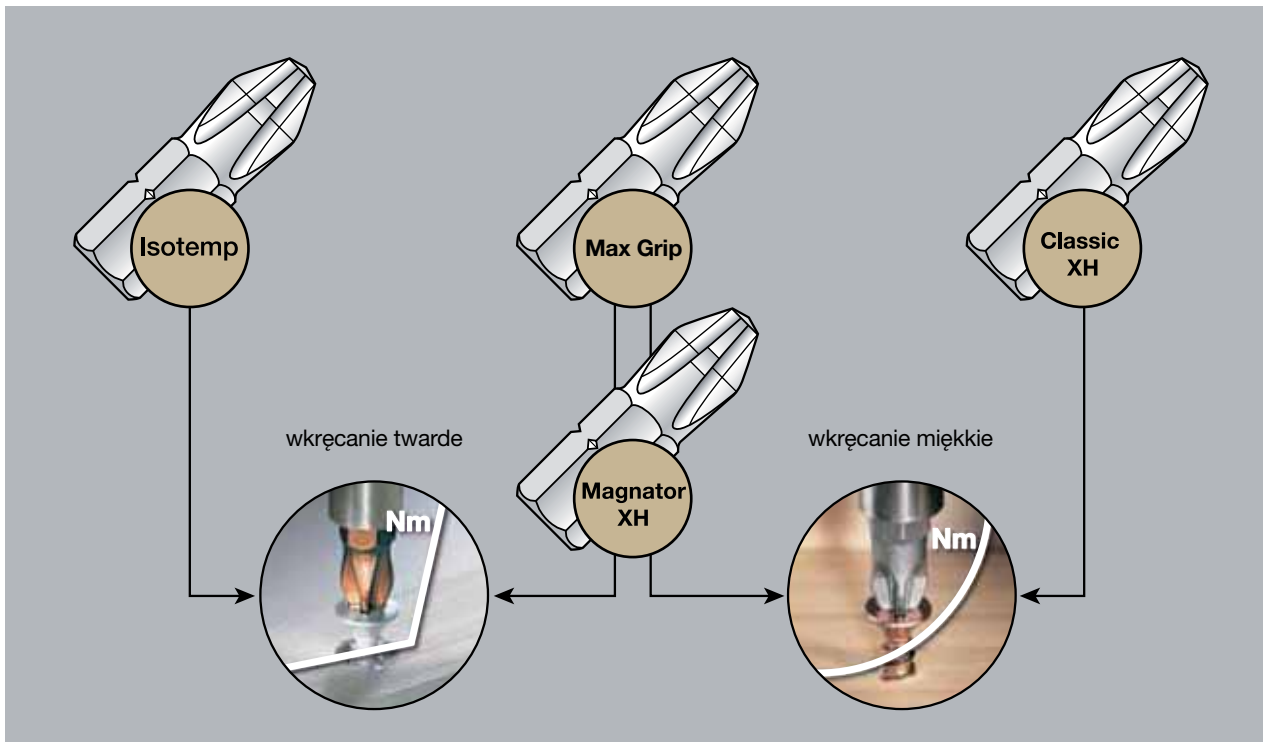

Bity serii **Classic XH** są przeznaczone zwłaszcza do miękkich zastosowań, przy których moment obrotowy podczas wkręcania wzrasta stopniowo.



Bity serii **Isotemp** są idealne do twardych zastosowań, przy których gwałtowny wzrost momentu obrotowego może prowadzić do nadmiernego obciążenia bitu. Bity Isotemp są poddawane specjalnej obróbce cieplnej, podczas której zyskują wyjątkową odporność na pęknięcie i ścieranie. Gwarantuje to wysoką trwałość bitów.



Bity serii **Magnator** to najbardziej uniwersalne bity w asortymencie MAGNA. Strefy skręcania o specjalnej geometrii umożliwiają wychwytywanie szczytowych wartości momentu obrotowego, co zwiększa odporność bitów na pęknięcie.



Bity serii **Max Grip** łączą w sobie doskonałą przyczepność z wysoką trwałością. Powierzchnia bitów jest chropowata, co zapewnia lepszą przyczepność do gniazda wkrętu. W celu zwiększenia ochrony przed zużyciem bity są powlekane azotkiem tytanu (TiN).

Wszystkie bity ze strefą skręcania są oznaczone w katalogu symbolem „+” (np. wersje Max Grip+, Magnator XH+).

Innowacje dzięki łączeniu cech

Bit **Max Grip** produkcji **MAGNA** łączy w sobie doskonałą przyczepność z wysoką trwałością. Przy produkcji bitów ze specjalnie hartowanej stali narzędziowej powierzchni bitu nadaje się chropowatość, która poprawia przyczepność, a następnie nakłada powłokę azotku tytanu (TiN), która zapewnia wysoką trwałość produktu. Powłoka tytanowa zabezpiecza chropowatą powierzchnię przed wygładzeniem i zmniejsza zużycie bitu.

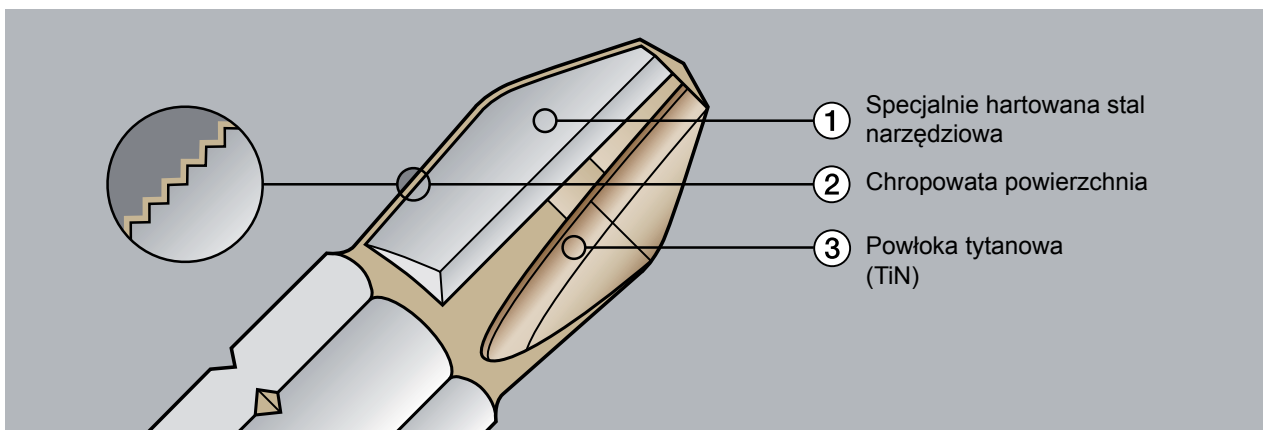

Rezultatem tego procesu jest wyjątkowo trwały bit, mocno przywierający do gniazda wkrętu bez ryzyka uszkodzenia go. Ponadto bit **Max Grip** posiada zoptymalizowaną geometrię, która zapewnia idealne dopasowanie do łba wkrętu, oraz strefę skręcania chroniącą bit przed pęknięciem przy szczytowych wartościach momentu obrotowego.

Mocne osadzenie w łbie wkrętu i wysoka trwałość

Max Grip to pierwszy bit, który łączy w sobie doskonałą przyczepność z wysoką trwałością. Wykres pokazuje porównanie właściwości przylegania do gniazda wkrętu oraz trwałość bitów powlekanych diamentami ①, zwykłych bitów z powłoką TiN ② oraz bitów konwencjonalnych ③.

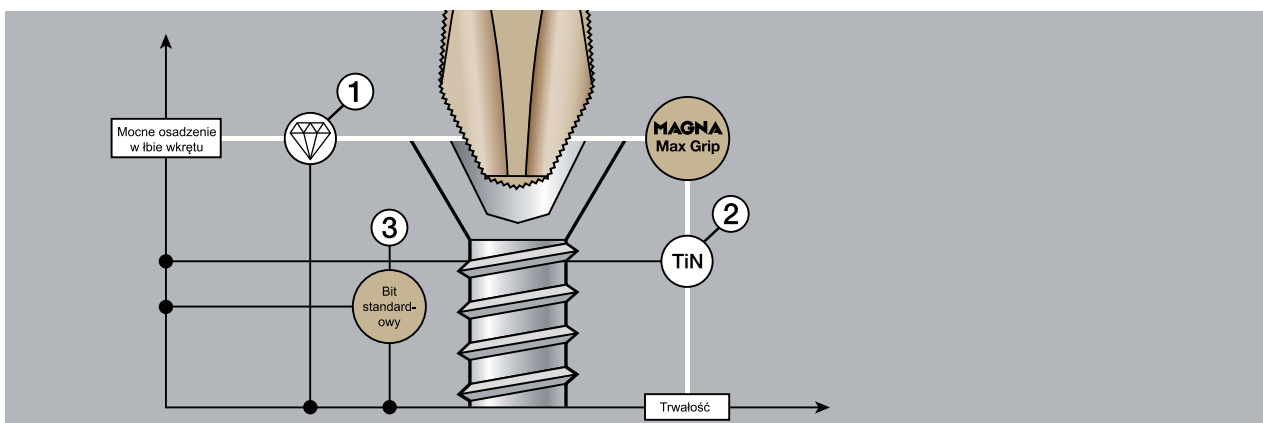

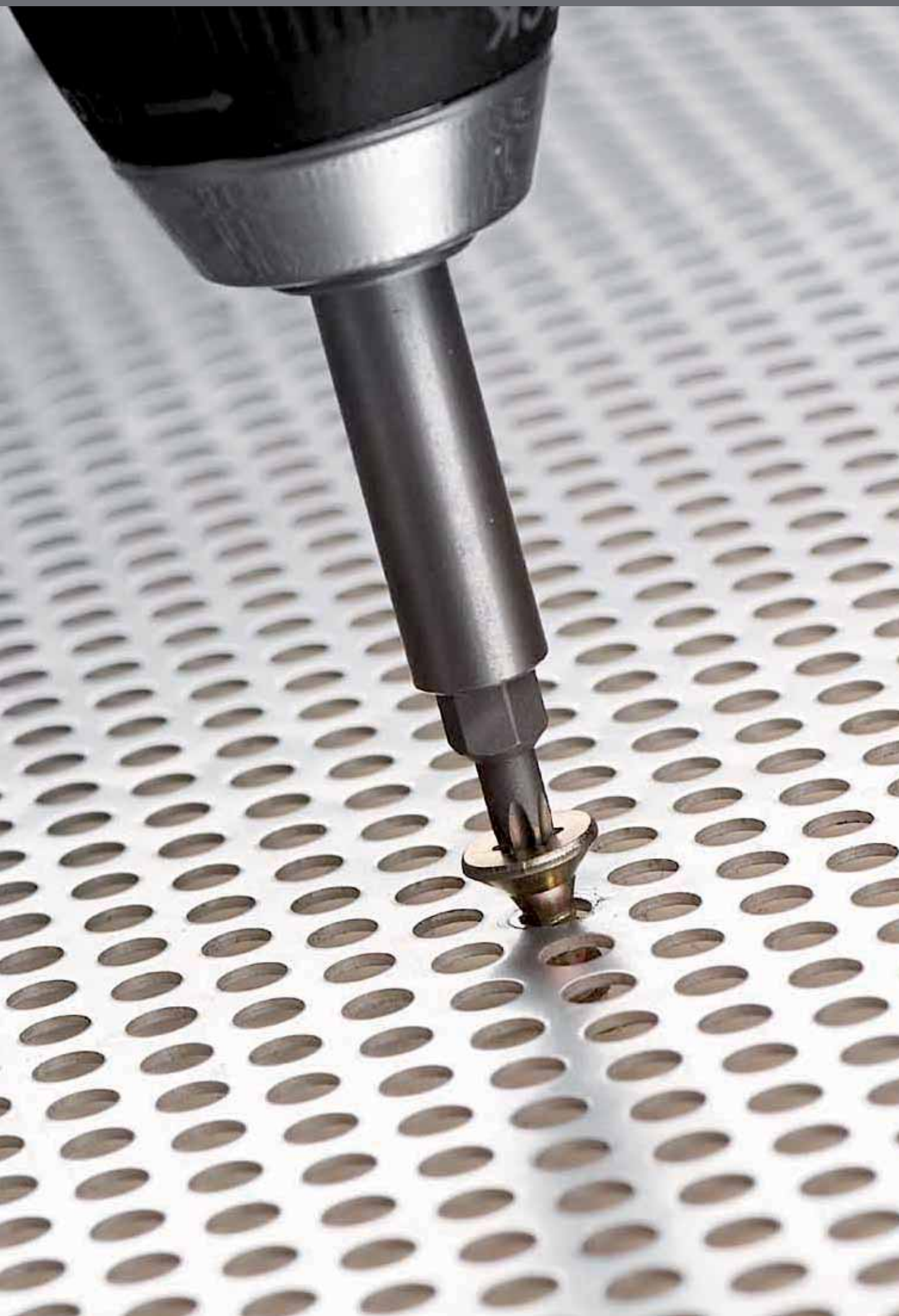

Spis treści

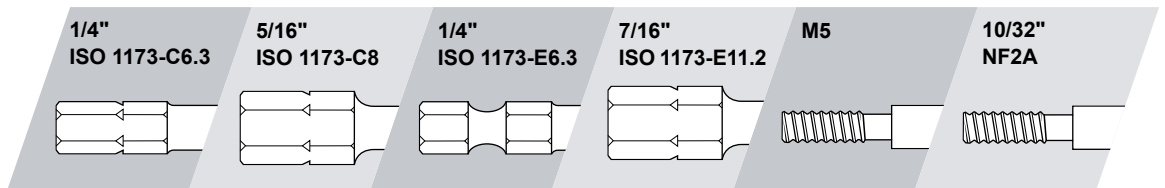

PZ Pozidriv	Strony 7/8	Strona 9	Strony 8/9	-	Strona 9	Strona 9
PH Phillips	Strony 10/11	Strona 13	Strony 11/12/13	-	Strona 13	Strona 13
T Torx®	Strona 14	Strona 16	Strony 14/15/16	-	-	-
TW Torxalign® (klin)	Strona 16	-	Strona 16	-	-	-
TH Torx® Tamper Resistant	Strona 17	-	-	-	-	-
LS Płaski	Strona 18	Strona 19	Strona 19	-	-	-
SW Sześciokątny	Strona 20	Strona 20	Strona 20	-	-	-
R Czworokątny	Strona 21	-	Strona 21	-	-	-
TQ Torq-Set®	Strona 22	Strona 22	Strona 22	Strona 23	-	-
TW Tri-Wing®	Strona 23	-	Strona 23	-	-	-
SP Napinacz	Strona 23	-	-	-	-	-
Bity podwójne	Strona 24	-	-	-	-	-

Uchwyty do bitów	Strony 25/26
Wkładki do kluczy nasadowych	Strony 27/28
Klucze nasadowe	Strona 28
Przedłużki	Strona 29
Wkręta	Strona 29

Torx® i Torxalign® są zarejestrowanymi znakami handlowymi firmy Acument Intellectual Properties, LLC.
 Pozidriv jest zarejestrowanym znakiem handlowym firmy European Industrial Services Ltd.
 Torq-Set® i Tri-Wing® są zarejestrowanymi znakami handlowymi firmy Phillips Screw Company.

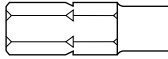

Końcówka	Długość mm	Nr katalogowy FOOY...	Zawartość opakowania	Opakowanie wysyłkowe	Kod kreskowy
----------	------------	--------------------------	-------------------------	-------------------------	--------------

Napęd ISO 1173-C6.3, chwyt zewnętrzny sześciokątny 1/4"

Wersja Classic XH

Pz0	25	221684	10	3	4014468058110
Pz1	25	216571	10	3	4014468056406
Pz1	25	224641	100	1	4014468064227
Pz2	25	216573	10	3	4014468056413
Pz2	25	224642	100	1	4014468064234
Pz3	25	216575	10	3	4014468056420
Pz3	25	224643	100	1	4014468064241
Pz4	32	221691	5	3	4014468058189

Wersja Max Grip+

Pz1	25	221692	10	3	4014468058196
Pz2	25	221693	10	3	4014468058202
Pz2	25	221694	100	1	4014468058219
Pz3	25	221695	10	3	4014468058226

Wersja Isotemp

Pz1	25	217176	10	3	4014468056499
Pz1	25	221697	100	1	4014468059674
Pz2	25	217177	10	3	4014468056505
Pz2	25	221699	100	1	4014468059681
Pz3	25	217216	10	3	4014468056512
Pz3	25	221701	100	1	4014468059698

Wersja Magnator XH+

Pz1	25	221685	10	3	4014468058127
Pz1	25	221686	100	1	4014468058134
Pz2	25	221687	10	3	4014468058141
Pz2	25	221688	100	1	4014468058158
Pz3	25	221689	10	3	4014468058165
Pz3	25	221690	100	1	4014468058172

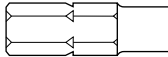

Napęd ISO 1173-C6.3, chwyt zewnętrzny sześciokątny 1/4", powierzchnia bitu karbowana

Wersja Classic XH

Pz1	25	216765	10	3	4014468056468
Pz2	25	216766	10	3	4014468056475
Pz2	25	221705	100	1	4014468059766
Pz3	25	216767	10	3	4014468056482

Wersja Isotemp

Pz1	25	217237	10	3	4014468056550
Pz2	25	217238	10	3	4014468056567
Pz2	25	221706	100	1	4014468059773
Pz3	25	217239	10	3	4014468056574



Napęd ISO 1173-C6.3, chwyt zewnętrzny sześciokątny 1/4", napęd bitu ze zredukowaną średnicą

Wersja Classic XH

Pz1R	25	224644	10	3	4014468064258
Pz2R	25	221707	10	3	4014468059780
Pz2R	25	221708	100	1	4014468059797

Wersja Isotemp

Pz2R	25	221709	10	3	4014468059803
Pz2R	25	221710	100	1	4014468059810

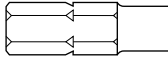

Końcówka	Długość mm	Nr katalogowy F00Y...	Zawartość opakowania	Opakowanie wysyłkowe	Kod kreskowy
----------	------------	-----------------------	----------------------	----------------------	--------------

Napęd ISO 1173-C6.3, chwyt zewnętrzny sześciokątny 1/4"

Wersja Classic XH

Pz1	50	221702	10	3	4014468059704
Pz2	50	221703	10	3	4014468059711
Pz3	50	221704	10	3	4014468059728

Wersja Isotemp

Pz2	50	222407	10	3	4014468059742
-----	----	--------	----	---	---------------

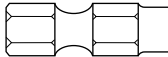

Napęd ISO 1173-E6.3, chwyt zewnętrzny sześciokątny 1/4"

Wersja Classic XH

Pz1	50	216617	5	5	4014468056437
Pz2	50	216618	5	5	4014468056444
Pz2	50	221719	100	1	4014468059902
Pz3	50	216619	5	5	4014468056451

Wersja Max Grip

Pz1	50	221720	5	5	4014468058233
Pz2	50	221721	5	5	4014468058240
Pz3	50	221722	5	5	4014468058257

Wersja Isotemp

Pz1	50	217217	5	5	4014468056529
Pz2	50	217218	5	5	4014468056536
Pz3	50	217219	5	5	4014468056543

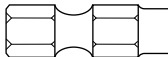

Napęd ISO 1173-E6.3, chwyt zewnętrzny sześciokątny 1/4", powierzchnia bitu karbowana

Wersja Classic XH

Pz1	50	221723	5	5	4014468059919
Pz2	50	221724	5	5	4014468059926
Pz3	50	221725	5	5	4014468059933

Wersja Isotemp

Pz1	50	221726	5	5	4014468059940
Pz2	50	221727	5	5	4014468059957
Pz3	50	221728	5	5	4014468059964

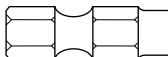

Napęd ISO 1173-E6.3, chwyt zewnętrzny sześciokątny 1/4"

Wersja dla wkrętarek udarowych

Pz2	50	265012	5	5	3165140424141
-----	----	--------	---	---	---------------

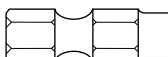

Napęd ISO 1173-E6.3, chwyt zewnętrzny sześciokątny 1/4"

Wersja Classic XH

Pz1	70	221731	5	2	4014468059971
Pz2	70	221732	5	2	4014468059988
Pz2	70	221733	100	1	4014468059995
Pz3	70	221734	5	2	4014468060007

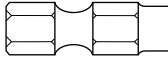

Końcówka

Długość mm

Nr katalogowy
FOOY...

Zawartość
opakowania

Opakowanie
wysyłkowe

Kod kreskowy



Napęd ISO 1173-E6.3, chwyt zewnętrzny sześciokątny 1/4"

Wersja Isotemp

Pz1	70	221735	5	2	4014468060014
Pz2	70	221737	5	2	4014468060038
Pz3	70	221736	5	2	4014468060021

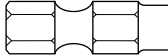

Napęd ISO 1173-E6.3, chwyt zewnętrzny sześciokątny 1/4"

Wersja Classic XH

Pz1	89	221738	5	2	4014468060045
Pz2	89	221739	5	2	4014468060052
Pz3	89	221740	5	2	4014468060069

Wersja Isotemp

Pz1	89	221741	5	2	4014468060076
Pz2	89	221742	5	2	4014468060083
Pz3	89	221743	5	2	4014468060090

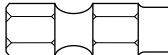

Napęd ISO 1173-E6.3, chwyt zewnętrzny sześciokątny 1/4"

Wersja Classic XH

Pz1	152	221747	5	1	4014468060106
Pz2	152	221748	5	1	4014468060113
Pz3	152	221749	5	1	4014468060120

Wersja Isotemp

Pz1	152	265015	5	1	3165140424172
Pz2	152	221751	5	1	4014468060144

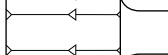

Napęd ISO 1173-C8, chwyt zewnętrzny sześciokątny 5/16"

Wersja Classic XH

Pz1	32	221711	5	5	4014468059827
Pz2	32	221712	5	5	4014468059834
Pz3	32	221713	5	5	4014468059841
Pz4	32	221714	5	5	4014468059858

Wersja Isotemp

Pz3	32	265019	5	5	3165140424219
------------	----	--------	---	---	---------------

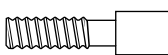

Napęd z gwintem M5

Wersja Classic XH

Pz1	45	221753	5	1	4014468060168
Pz2	45	221754	5	1	4014468060175
Pz2	45	221755	5	1	4014468060182

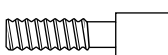

Napęd z gwintem 10/32"

Wersja Classic XH

Pz2	45	221756	5	1	4014468060199
------------	----	--------	---	---	---------------

Minimalna wielkość zamówienia dla każdego numeru katalogowego = zawartość opakowania x opakowanie wysyłkowe
Ilości nieodpowiadające podanym wielkościom wysyłkowym (np. 5-> 10-> 15) zostaną automatycznie zaakrąglone do kolejnej, wyższej wielkości zamówienia.

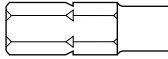

Końcówka	Długość mm	Nr katalogowy F00Y...	Zawartość opakowania	Opakowanie wysyłkowe	Kod kreskowy
----------	------------	-----------------------	----------------------	----------------------	--------------

Napęd ISO 1173-C6.3, chwyt zewnętrzny sześciokątny 1/4"

Wersja Classic XH

Ph0	25	221759	10	3	4014468058332
Ph0	25	221760	100	1	4014468058349
Ph1	25	216559	10	3	4014468056598
Ph1	25	224645	100	1	4014468064265
Ph2	25	216561	10	3	4014468056604
Ph2	25	224646	100	1	4014468064272
Ph3	25	216563	10	3	4014468056611
Ph3	25	224647	100	1	4014468064289
Ph4	32	221767	5	3	4014468058417

Wersja Max Grip+

Ph1	25	221768	10	3	4014468058424
Ph2	25	221769	10	3	4014468058431
Ph2	25	221770	100	1	4014468058448
Ph3	25	221771	10	3	4014468058455

Wersja Isotemp

Ph0	25	265277	10	3	3165140531276
Ph1	25	217190	10	3	4014468056642
Ph2	25	217191	10	3	4014468056659
Ph2	25	221774	100	1	4014468060205
Ph3	25	217192	10	3	4014468056666

Wersja Magnator XH+

Ph1	25	221761	10	3	4014468058356
Ph1	25	221762	100	1	4014468058356
Ph2	25	221763	10	3	4014468058370
Ph2	25	221764	100	1	4014468058387
Ph3	25	221765	10	3	4014468058394
Ph3	25	221766	100	1	4014468058400

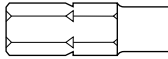

Napęd ISO 1173-C6.3, chwyt zewnętrzny sześciokątny 1/4", powierzchnia karbowana

Wersja Classic XH

Ph1	25	217255	10	3	4014468056703
Ph2	25	217257	10	3	4014468056710
Ph2	25	221783	100	1	4014468060281
Ph3	25	221784	10	3	4014468060298

Wersja Isotemp

Ph1	25	221785	10	3	4014468060304
Ph2	25	221786	10	3	4014468060311
Ph3	25	221787	10	3	4014468060328

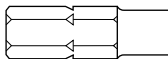

Napęd ISO 1173-C6.3, chwyt zewnętrzny sześciokątny 1/4", napęd bitu ze zredukowaną średnicą

Wersja Classic XH

Ph1R	25	221788	10	3	4014468060335
Ph1R	25	221789	100	1	4014468060342
Ph2R	25	221790	10	3	4014468060359
Ph2R	25	221791	100	1	4014468060366

Wersja Isotemp

Ph2R	25	221793	10	3	4014468060380
------	----	--------	----	---	---------------

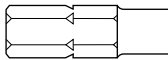

Końcówka	Długość mm	Nr katalogowy F00Y...	Zawartość opakowania	Opakowanie wysyłkowe	Kod kreskowy
----------	------------	-----------------------	----------------------	----------------------	--------------



Napęd ISO 1173-C6.3, chwyt zewnętrzny sześciokątny 1/4", napęd bitu ze zredukowaną średnicą

Wersja Classic XH	Ph1R	50	221794	5	3	4014468060397
	Ph2R	50	221795	5	3	4014468060403

Wersja Classic XH	Ph2R	76	221796	5	1	4014468060410
-------------------	------	----	--------	---	---	---------------

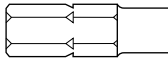

Napęd ISO 1173-C6.3, chwyt zewnętrzny sześciokątny 1/4"

Wersja Classic XH	Ph2	38	221777	10	3	4014468060229
-------------------	-----	----	--------	----	---	---------------

Wersja Classic XH	Ph1	50	221776	10	3	4014468060212
	Ph2	50	221778	10	3	4014468060236
	Ph3	50	221780	10	3	4014468060250

Wersja Classic XH	Ph2	64	221779	10	3	4014468060243
-------------------	-----	----	--------	----	---	---------------

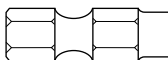

Napęd ISO 1173-E6.3, chwyt zewnętrzny sześciokątny 1/4"

Wersja Classic XH	Ph0	50	217123	5	5	4014468056772
	Ph1	50	216608	5	5	4014468056727
	Ph2	50	216609	5	5	4014468056734
	Ph2	50	221809	100	1	4014468060526
	Ph3	50	216610	5	5	4014468056741

Wersja Max Grip	Ph1	50	221810	5	5	4014468058486
	Ph2	50	221811	5	5	4014468058493
	Ph3	50	221812	5	5	4014468058509

Wersja Isotemp	Ph0	50	265278	5	5	3165140531283
	Ph1	50	216804	5	5	4014468056758
	Ph2	50	217290	5	5	4014468056789
	Ph2	50	221813	100	1	4014468060533
	Ph3	50	216805	5	5	4014468056765



Napęd ISO 1173-E6.3, chwyt zewnętrzny sześciokątny 1/4"

Wersja Classic XH	Ph1	50	221814	5	5	4014468060540
	Ph2	50	221815	5	5	4014468060557
	Ph3	50	221816	5	5	4014468060564

Wersja Isotemp	Ph1	50	221817	5	5	4014468060571
	Ph2	50	221818	5	5	4014468060588
	Ph3	50	221819	5	5	4014468060595

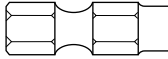

Końcówka	Długość mm	Nr katalogowy F00Y...	Zawartość opakowania	Opakowanie wysyłkowe	Kod kreskowy
----------	------------	-----------------------	----------------------	----------------------	--------------



Napęd ISO 1173-E6.3, chwyt zewnętrzny sześciokątny 1/4", powierzchnia karbowana

Wersja Classic XH	Ph1	50	221820	5	5	4014468060601
	Ph2	50	221821	5	5	4014468060618
Ph3	50	221822	5	5	4014468060625	

Wersja Isotemp	Ph1	50	221823	5	5	4014468060632
	Ph2	50	221824	5	5	4014468060649
	Ph3	50	221825	5	5	4014468060656

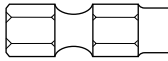

Napęd ISO 1173-E6.3, chwyt zewnętrzny sześciokątny 1/4"

Wersja Classic XH	Ph1	70	221826	5	2	4014468060663
	Ph2	70	221827	5	2	4014468060670
	Ph2	70	221828	100	1	4014468060687
	Ph3	70	221829	5	2	4014468060694

Wersja Isotemp	Ph1	70	265279	5	2	3165140531290
	Ph2	70	221831	5	2	4014468060717
	Ph3	70	265280	5	2	3165140531306

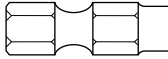

Napęd ISO 1173-E6.3, chwyt zewnętrzny sześciokątny 1/4"

Wersja Classic XH	Ph1	89	222394	5	2	4014468060731
	Ph2	89	222395	5	2	4014468060748
	Ph2	89	222396	100	1	4014468060755
	Ph3	89	221833	5	2	4014468060762

Wersja Isotemp	Ph1	89	221834	5	2	4014468060779
	Ph2	89	221835	5	2	4014468060786
	Ph3	89	221836	5	2	4014468060793

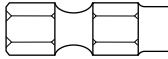

Napęd ISO 1173-E6.3, chwyt zewnętrzny sześciokątny 1/4"

Wersja Classic XH	Ph1	102	221837	5	1	4014468060809
	Ph2	102	221838	5	1	4014468060816
	Ph2	102	221839	100	1	4014468060823
	Ph3	102	221840	5	1	4014468060830

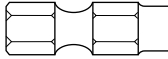

Koncówka	Długość mm	Nr katalogowy F00Y...	Zawartość opakowania	Opakowanie wysyłkowe	Kod kreskowy
----------	------------	-----------------------	----------------------	----------------------	--------------



Napęd ISO 1173-E6.3, chwyt zewnętrzny sześciokątny 1/4"

Wersja Classic XH

Ph1	152	221844	5	1	4014468060847
Ph2	152	221845	5	1	4014468060854
Ph3	152	221846	5	1	4014468060861

Wersja Isotemp

Ph2	152	221848	5	1	4014468060885
------------	-----	--------	---	---	---------------

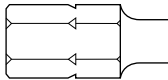

Napęd ISO 1173-C8, chwyt zewnętrzny sześciokątny 5/16"

Wersja Classic XH

Ph1	32	221797	5	5	4014468060427
Ph2	32	221798	5	5	4014468060434
Ph3	32	221799	5	5	4014468060441
Ph4	32	221800	5	5	4014468060458

Wersja Isotemp

Ph2	32	265020	5	5	3165140424226
------------	----	--------	---	---	---------------

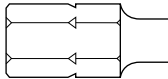

Napęd ISO 1173-C8, chwyt zewnętrzny sześciokątny 5/16", powierzchnia bitu karbowana

Wersja Classic XH

Ph2	35	221805	10	2	4014468060502
------------	----	--------	----	---	---------------

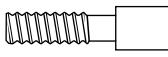

Napęd z gwintem M5

Wersja Classic XH

Ph1	45	221852	5	1	4014468060908
Ph2	45	221853	5	1	4014468060915
Ph3	45	221854	5	1	4014468060922

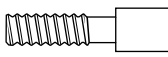

Napęd z gwintem 10/32"

Wersja Classic XH

Ph2	45	221855	5	1	4014468060939
------------	----	--------	---	---	---------------

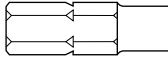

Końcówka	Długość mm	Nr katalogowy F00Y...	Zawartość opakowania	Opakowanie wysyłkowe	Kod kreskowy
----------	------------	-----------------------	----------------------	----------------------	--------------

Napęd ISO 1173-C6.3, chwyt zewnętrzny sześciokątny 1/4"

Wersja Classic XH

T 6	25	221857	5	5	4014468060946
T 7	25	221858	5	5	4014468060953
T 8	25	221859	5	5	4014468060960
T 9	25	221860	5	5	4014468060977
T 10	25	216984	10	3	4014468056871
T 10	25	221861	100	1	4014468060984
T 15	25	216985	10	3	4014468056888
T 15	25	221862	100	1	4014468060991
T 20	25	216986	10	3	4014468056895
T 20	25	221863	100	1	4014468061004
T 25	25	216987	10	3	4014468056901
T 25	25	221864	100	1	4014468061011
T 27	25	216988	10	3	4014468056918
T 27	25	221865	100	1	4014468061028
T 30	25	216989	10	3	4014468056925
T 30	25	221866	100	1	4014468061035
T 40	25	216990	10	3	4014468056932
T 40	25	221867	100	1	4014468061042

Wersja Max Grip

T 8	25	221872	5	5	4014468058578
T 10	25	221873	10	3	4014468058585
T 15	25	221874	10	3	4014468058592
T 20	25	221875	10	3	4014468058622
T 25	25	221876	10	3	4014468058622
T 27	25	221877	10	3	4014468058646
T 30	25	221878	10	3	4014468058653
T 40	25	221879	10	3	4014468058660

Wersja Isotemp

T 10	25	216845	10	3	4014468056802
T 15	25	216846	10	3	4014468056819
T 20	25	216847	10	3	4014468056826
T 25	25	216848	10	3	4014468056833
T 27	25	216849	10	3	4014468056840
T 30	25	216850	10	3	4014468056857
T 40	25	216851	10	3	4014468056864

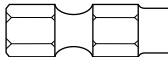

Napęd ISO 1173-E6.3, chwyt zewnętrzny sześciokątny 1/4"

Wersja Classic XH

T 6	50	222055	5	5	4014468059384
T 7	50	221920	5	5	4014468061196
T 8	50	221921	5	5	4014468061202
T 9	50	221922	5	5	4014468061219
T 10	50	217017	5	5	4014468056949
T 15	50	217018	5	5	4014468056956
T 20	50	217019	5	5	4014468056963
T 25	50	217020	5	5	4014468056970
T 27	50	217021	5	5	4014468056987
T 30	50	217022	5	5	4014468056994
T 40	50	217023	5	5	4014468057007

Minimalna wielkość zamówienia dla każdego numeru katalogowego = zawartość opakowania x opakowanie wysyłkowe
 ilości nieodpowiadające podanym wielkościom wysyłkowym (np. 5 -> 10 -> 15) zostaną automatycznie zaokrąglone do kolejnej, wyższej wielkości zamówienia.

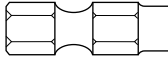

Końcówka	Długość mm	Nr katalogowy F00Y...	Zawartość opakowania	Opakowanie wysyłkowe	Kod kreskowy
----------	------------	-----------------------	----------------------	----------------------	--------------

Napęd ISO 1173-E6.3, chwyt zewnętrzny sześciokątny 1/4"

Wersja Isotemp

T 7	50	265281	5	5	3165140531313
T 8	50	265282	5	5	3165140531320
T 9	50	265283	5	5	3165140531337
T 10	50	217208	5	5	4014468057021
T 15	50	217209	5	5	4014468057038
T 20	50	217210	5	5	4014468057045
T 25	50	217211	5	5	4014468057052
T 27	50	217140	5	5	4014468057014
T 30	50	217212	5	5	4014468057069
T 40	50	218020	5	5	4014468057076

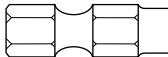

Napęd ISO 1173-E6.3, chwyt zewnętrzny sześciokątny 1/4"

Wersja Classic XH

T 8	70	221941	5	2	4014468061257
T 9	70	221942	5	2	4014468061264
T 10	70	221943	5	2	4014468061271
T 15	70	221944	5	2	4014468061288
T 20	70	221945	5	2	4014468061295
T 25	70	221946	5	2	4014468061318
T 27	70	221947	5	2	4014468061325
T 30	70	221948	5	2	4014468061332
T 40	70	221949	5	2	4014468061349



Napęd ISO 1173-E6.3, chwyt zewnętrzny sześciokątny 1/4"

Wersja Classic XH

T 8	89	221950	5	1	4014468061356
T 9	89	221951	5	1	4014468061363
T 10	89	221952	5	1	4014468061370
T 15	89	221953	5	1	4014468061387
T 20	89	221954	5	1	4014468061394
T 25	89	221955	5	1	4014468061400
T 27	89	221956	5	1	4014468061417
T 30	89	221957	5	1	4014468061424
T 40	89	221958	5	1	4014468061431

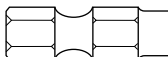

Napęd ISO 1173-E6.3, chwyt zewnętrzny sześciokątny 1/4"

Wersja Classic XH

T 8	152	221968	5	1	4014468061530
T 10	152	221969	5	1	4014468061547
T 15	152	221970	5	1	4014468061554
T 20	152	221971	5	1	4014468061561
T 25	152	221972	5	1	4014468061578
T 27	152	221973	5	1	4014468061585

Minimalna wielkość zamówienia dla każdego numeru katalogowego = zawartość opakowania x opakowanie wysyłkowe
Ilości nieodpowiadające podanym wielkościom wysyłkowym (np. 5 -> 10 -> 15) zostaną automatycznie zaakrąglone do kolejnej, wyższej wielkości zamówienia.

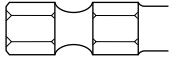

Końcówka	Długość mm	Nr katalogowy F00Y...	Zawartość opakowania	Opakowanie wysyłkowe	Kod kreskowy
----------	------------	-----------------------	----------------------	----------------------	--------------



Napęd ISO 1173-E6.3, chwyt zewnętrzny sześciokątny 1/4"

Wersja Classic XH

T 30	152	221974	5	1	4014468061592
T 40	152	221975	5	1	4014468061608

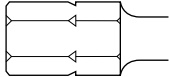

Napęd ISO 1173-C8, chwyt zewnętrzny sześciokątny 5/16"

Wersja Classic XH

T 30	35	221891	5	2	4014468061097
T 40	35	221892	5	2	4014468061103
T 45	35	221893	5	2	4014468061110
T 50	35	221895	5	2	4014468063978
T 55	35	221896	5	2	4014468063985

Torxalign® (klin)



Napęd ISO 1173-C6.3, chwyt zewnętrzny sześciokątny 1/4"

Wersja Classic XH

T 10 W	25	221980	5	1	4014468061653
T 15 W	25	221981	5	1	4014468061660
T 20 W	25	221982	5	1	4014468061677
T 25 W	25	221983	5	1	4014468061684
T 30 W	25	221985	5	1	4014468061707

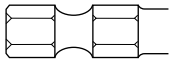

Napęd ISO 1173-E6.3, chwyt zewnętrzny sześciokątny 1/4"

Wersja Classic XH

T 10 W	50	221990	5	1	4014468061769
T 15 W	50	221991	5	1	4014468061776
T 20 W	50	221992	5	1	4014468061783
T 25 W	50	221993	5	1	4014468061790
T 30 W	50	221995	5	1	4014468061813

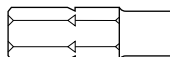

Końcówka

Długość mm

Nr katalogowy
FOOY...Zawartość
opakowaniaOpakowanie
wysyłkowe

Kod kreskowy

Napęd ISO 1173-C6.3, chwyt zewnętrzny sześciokątny 1/4"

Wersja Classic XH

T 7H	25	221996	5	3	4014468061820
T 8H	25	221997	5	3	4014468061837
T 9H	25	221998	5	3	4014468061844
T 10H	25	221999	5	3	4014468061851
T 15H	25	222000	5	3	4014468061868
T 20H	25	222001	5	3	4014468061875
T 25H	25	222002	5	3	4014468061882
T 27H	25	222003	5	3	4014468061899
T 30H	25	222004	5	3	4014468061905
T 40H	25	222005	5	3	4014468061912

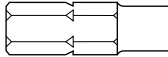

Końcówka	Długość mm	Nr katalogowy F00Y...	Zawartość opakowania	Opakowanie wysyłkowe	Kod kreskowy
----------	------------	-----------------------	----------------------	----------------------	--------------

Napęd ISO 1173-C6.3, chwyt zewnętrzny sześciokątny 1/4"

Wersja Classic XH

S0,5x3,0	25	222060	10	3	4014468059438
S0,5x4,0	25	217156	10	3	4014468057120
S0,6x4,5	25	217157	10	3	4014468057137
S0,8x5,5	25	217158	10	3	4014468057144
S1,0x5,5	25	222009	10	3	4014468059155
S1,0x6,0	25	222010	10	3	4014468059162
S1,2x6,5	25	217160	10	3	4014468057168
S1,2x8,0	25	217161	10	3	4014468057175
S1,6x8,0	25	222013	10	3	4014468059193
S0-1	25	222027	5	5	4014468061929
S1-2	25	222028	5	5	4014468061936
S2-3	25	222029	5	5	4014468061943
S3-4	25	222030	5	5	4014468061950
S4-5	25	222031	5	5	4014468061967
S5-6	25	222032	5	5	4014468061974
S6-8	25	222033	5	5	4014468061981
S8-10	25	222034	5	5	4014468061998
S10-12	25	222035	5	5	4014468062001
S12-14	25	222036	5	5	4014468062018

Wersja Max Grip+

S0,5x4,0	25	221887	10	3	4014468058745
S0,6x4,5	25	222023	10	3	4014468059209
S0,8x5,5	25	222024	10	3	4014468059216
S1,0x5,5	25	221888	10	3	4014468058752
S1,2x6,5	25	221889	10	3	4014468058769
S1,2x8,0	25	222025	10	3	4014468059223
S1,6x8,0	25	222026	10	3	4014468059230

Wersja Isotemp

S0,5x3,0	25	265292	10	3	3165140532457
S0,5x4,0	25	217226	10	3	4014468057298
S0,6x4,5	25	217227	10	3	4014468057304
S0,8x5,5	25	217220	10	3	4014468057267
S1,0x5,5	25	217221	10	3	4014468057274
S1,0x6,0	25	216773	10	3	4014468057090
S1,2x6,5	25	217222	10	3	4014468057281
S1,2x8,0	25	217228	10	3	4014468057311
S1,6x8,0	25	217229	10	3	4014468057328
S8-10	25	265017	5	5	3165140424196

Wersja Magnator XH+

S0,5x4,0	25	222006	10	3	4014468059124
S0,6x4,5	25	222007	10	3	4014468059131
S0,8x5,5	25	222008	10	3	4014468059148
S1,0x5,5	25	265634	10	3	3165140577571
S1,2x6,5	25	222011	10	3	4014468059179
S1,2x8,0	25	222012	10	3	4014468059186

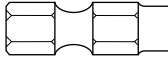

Końcówka	Długość mm	Nr katalogowy F00Y...	Zawartość opakowania	Opakowanie wysyłkowe	Kod kreskowy
----------	------------	-----------------------	----------------------	----------------------	--------------

Napęd ISO 1173-E6.3, chwyt zewnętrzny sześciokątny 1/4"

Wersja Classic XH

S0,5x3,0	50	222037	5	5	4014468059247
S0,5x4,0	50	222038	5	5	4014468062025
S0,6x4,5	50	222039	5	5	4014468062032
S0,8x5,5	50	222040	5	5	4014468062056
S1,0x5,5	50	222041	5	5	4014468062063
S1,0x6,0	50	222042	5	5	4014468062087
S1,2x6,5	50	222043	5	5	4014468062094
S1,2x8,0	50	222044	5	5	4014468062100
S1,6x8,0	50	222045	5	5	4014468062117

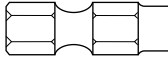

Napęd ISO 1173-E6.3, chwyt zewnętrzny sześciokątny 1/4"

Wersja Classic XH

S0,5x3,0	70	222047	5	2	4014468059308
S0,6x4,5	70	222049	5	2	4014468059322
S0,8x5,5	70	222050	5	2	4014468059339
S1,0x5,5	70	222051	5	2	4014468059346
S1,2x6,5	70	222052	5	2	4014468059353

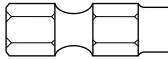

Napęd ISO 1173-E6.3, chwyt zewnętrzny sześciokątny 1/4"

Wersja Classic XH

S0,8x5,5	89	222056	5	2	4014468059391
S1,0x5,5	89	222057	5	2	4014468059407
S1,2x6,5	89	222058	5	2	4014468059414
S1,2x8,0	89	222059	5	2	4014468059421

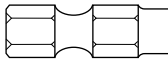

Napęd ISO 1173-E6.3, chwyt zewnętrzny sześciokątny 1/4"

Wersja Classic XH

S6-8	89/95	265013	10	1	3165140424165
S8-10	89/95	265014	10	1	3165140424158

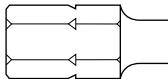

Napęd ISO 1173-C8, chwyt zewnętrzny sześciokątny 5/16"

Wersja Classic XH

S16-18	32	265018	5	1	3165140424202
---------------	----	--------	---	---	---------------

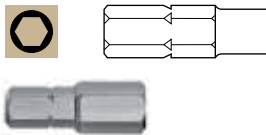

Końcówka	Długość mm	Nr katalogowy F00Y...	Zawartość opakowania	Opakowanie wysyłkowe	Kod kreskowy
----------	------------	-----------------------	----------------------	----------------------	--------------

Napęd ISO 1173-C6.3, chwyt zewnętrzny sześciokątny 1/4"

Wersja Classic XH

1.5	25	222071	5	5	4014468062179
2	25	222072	5	5	4014468062186
2.5	25	222073	5	5	4014468062193
3	25	222074	10	3	4014468062209
4	25	222075	10	3	4014468062216
5	25	222076	10	3	4014468062223
6	25	222077	10	3	4014468062230
7	25	222078	5	5	4014468062247
8	25	222079	5	5	4014468062254
5/64"	25	222091	5	5	4014468062384
3/32"	25	222092	5	5	4014468062391
7/64"	25	222093	5	5	4014468062407
1/8"	25	222094	5	5	4014468062414
9/64"	25	222095	5	5	4014468062421
5/32"	25	222096	5	5	4014468062438
3/16"	25	222097	5	5	4014468062445
7/32"	25	222098	5	5	4014468062452
1/4"	25	222099	5	5	4014468062469
5/16"	25	222100	5	5	4014468062476
3/8"	25	222101	5	5	4014468062483

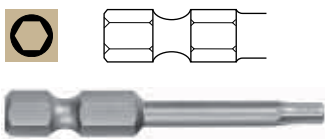

Napęd ISO 1173-E6.3, chwyt zewnętrzny sześciokątny 1/4"

Wersja Classic XH

2	50	222120	5	5	4014468062667
2.5	50	222121	5	5	4014468062674
3	50	222122	5	5	4014468062681
4	50	222123	5	5	4014468062698
5	50	222124	5	5	4014468062704
5/64"	50	265011	5	5	3165140424134

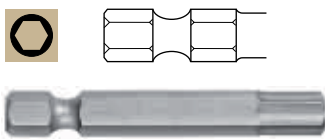

Napęd ISO 1173-E6.3, chwyt zewnętrzny sześciokątny 1/4"

Wersja Classic XH

6	50	222116	5	5	4014468062636
8	50	222118	5	5	4014468062643
10	50	222119	5	5	4014468062650

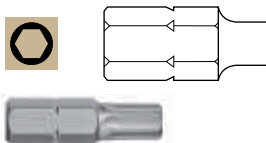

Napęd ISO 1173-C8, chwyt zewnętrzny sześciokątny 5/16"

Wersja Classic XH

3	30	222102	5	5	4014468062490
4	30	222103	5	5	4014468062506
5	30	222104	5	5	4014468062513
6	30	222105	5	5	4014468062520
7	30	222106	5	5	4014468062537
8	30	222107	5	5	4014468062544
10	30	222108	5	5	4014468062551
12	30	222109	5	5	4014468062568
14	30	222110	5	5	4014468062575

Minimalna wielkość zamówienia dla każdego numeru katalogowego = zawartość opakowania x opakowanie wysyłkowe
Ilości nieodpowiadające podanym wielkościom wysyłkowym (np. 5-> 10-> 15) zostaną automatycznie zaakraglone do kolejnej, wyższej wielkości zamówienia.

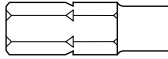

Końcówka

Długość mm

Nr katalogowy
F00Y...

Zawartość
opakowania

Opakowanie
wysyłkowe

Kod kreskowy



Napęd ISO 1173-C6.3, chwyt zewnętrzny sześciokątny 1/4"

Wersja Classic XH

R0	25	222135	5	5	4014468062810
R1	25	222136	5	5	4014468062827
R2	25	222137	5	5	4014468062834
R2	25	222138	100	1	4014468062841
R3	25	222139	5	5	4014468062858

Wersja Isotemp

R0	25	222140	5	5	4014468062865
R1	25	222141	5	5	4014468062872
R2	25	222142	5	5	4014468062889
R3	25	222143	5	5	4014468062896

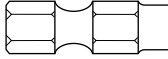

Napęd ISO 1173-E6.3, chwyt zewnętrzny sześciokątny 1/4"

Wersja Classic XH

R1	50	222144	5	5	4014468062902
R2	50	222145	5	5	4014468062919
R2	50	222146	100	1	4014468062926
R3	50	222147	5	5	4014468062933

Wersja Isotemp

R1	50	222148	5	5	4014468062940
R2	50	222149	5	5	4014468062957
R3	50	222150	5	5	4014468062964

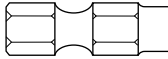

Napęd ISO 1173-E6.3, chwyt zewnętrzny sześciokątny 1/4"

Wersja Classic XH

R1	70	222151	5	2	4014468062971
R2	70	222152	5	2	4014468062988
R3	70	222153	5	2	4014468062995

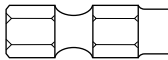

Napęd ISO 1173-E6.3, chwyt zewnętrzny sześciokątny 1/4"

Wersja Classic XH

R1	89	222154	5	2	4014468063015
R2	89	222155	5	2	4014468063022

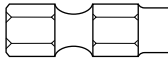

Napęd ISO 1173-E6.3, chwyt zewnętrzny sześciokątny 1/4"

Wersja Classic XH

R2	102	222156	5	1	4014468063053
----	-----	--------	---	---	---------------

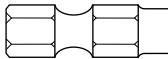

Napęd ISO 1173-E6.3, chwyt zewnętrzny sześciokątny 1/4"

Wersja Classic XH

R1	152	222157	5	1	4014468063060
R2	152	222158	5	1	4014468063077
R3	152	222159	5	1	4014468063084

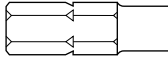

Końcówka	Długość mm	Nr katalogowy F00Y...	Zawartość opakowania	Opakowanie wysyłkowe	Kod kreskowy
----------	------------	-----------------------	----------------------	----------------------	--------------

Napęd ISO 1173-C6.3, chwyt zewnętrzny sześciokątny 1/4"

Wersja Isotemp

0	25	222160	5	1	4014468063091
1	25	222161	5	1	4014468063107
2	25	222162	5	1	4014468063121
3	25	222163	5	1	4014468063138
4	25	222164	5	1	4014468063145
5	25	222165	5	1	4014468063152
6	25	222166	5	1	4014468063169
8	25	222167	5	1	4014468063176
10	25	222168	5	1	4014468063183

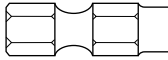

Napęd ISO 1173-E6.3, chwyt zewnętrzny sześciokątny 1/4"

Wersja Isotemp

0	32	222174	5	1	4014468063244
1	32	222175	5	1	4014468063251
2	32	222176	5	1	4014468063268
3	32	222177	5	1	4014468063275
4	32	222178	5	1	4014468063282
5	32	222179	5	1	4014468063299
6	32	222180	5	1	4014468063305
8	32	222181	5	1	4014468063312
10	32	222182	5	1	4014468063329

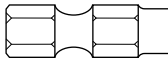

Napęd ISO 1173-E6.3, chwyt zewnętrzny sześciokątny 1/4"

Wersja Isotemp

0	50	265625	5	1	3165140576741
1	50	265626	5	1	3165140576758
2	50	265627	5	1	3165140576965
3	50	265628	5	1	3165140576772
4	50	265629	5	1	3165140576789
5	50	265630	5	1	3165140576796
6	50	265631	5	1	3165140576802
8	50	265632	5	1	3165140576819
10	50	265633	5	1	3165140576826

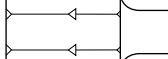

Napęd ISO 1173-C8, chwyt zewnętrzny sześciokątny 5/16"

Wersja Isotemp

1/4"	32	222171	5	1	4014468063213
5/16"	32	222172	5	1	4014468063220
3/8"	32	222173	5	1	4014468063237
10	32	224648	5	1	4014468064296

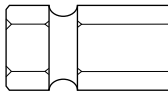

Końcówka	Długość mm	Nr katalogowy F00Y...	Zawartość opakowania	Opakowanie wysyłkowe	Kod kreskowy
----------	------------	-----------------------	----------------------	----------------------	--------------

Napęd ISO 1173-E11.2, chwyt zewnętrzny sześciokątny 7/16"

Wersja Isotemp

1/4"	35	222402	5	1	4014468063336
5/16"	35	222403	5	1	4014468063343
3/8"	35	224649	5	1	4014468064302
7/16"	35	222405	5	1	4014468063367

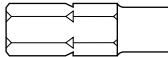

Napęd ISO 1173-C6.3, chwyt zewnętrzny sześciokątny 1/4"

Wersja Isotemp

0	25	222183	5	2	4014468063381
1	25	222184	5	2	4014468063398
2	25	222185	5	2	4014468063404
3	25	222186	5	2	4014468063411
4	25	222187	5	2	4014468063428
5	25	222188	5	2	4014468063435
6	32	222189	5	2	4014468063442

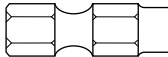

Napęd ISO 1173-E6.3, chwyt zewnętrzny sześciokątny 1/4"

Wersja Isotemp

0	50	222190	5	2	4014468063459
1	50	222191	5	2	4014468063466
2	50	222192	5	2	4014468063473
3	50	222193	5	2	4014468063480
4	50	222194	5	2	4014468063497
5	50	222195	5	2	4014468063503

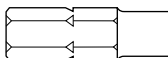

Napęd ISO 1173-C6.3, chwyt zewnętrzny sześciokątny 1/4"

Wersja Isotemp

SP 6	25	224650	5	2	4014468064371
SP 8	25	224651	5	2	4014468064388
SP10	25	224652	5	2	4014468064395

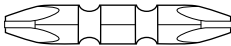
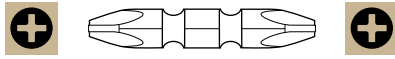

Końcówka, 1. bit	Końcówka, 2. bit	Długość mm	Nr katalogowy FOOY...	Zawartość opakowania	Opakowanie wysyłkowe	Kod kreskowy
---------------------	---------------------	------------	--------------------------	-------------------------	-------------------------	--------------

Bity podwójne 1/4"

Wersja Classic XH	Ph2	Ph2	45	222220	10	2	4014468063589
-------------------	-----	-----	----	--------	----	---	---------------

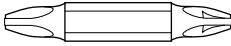
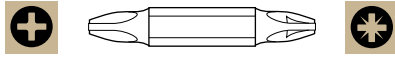

Wersja Classic XH	Ph2	Pz2	45	222221	10	2	4014468063596
-------------------	-----	-----	----	--------	----	---	---------------

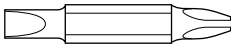
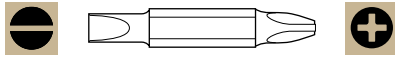

Wersja Classic XH	S1,0x5,5	Ph2	45	222224	10	2	4014468063626
	S0,8x5,5	Ph2	60	222225	10	1	4014468063633

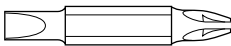
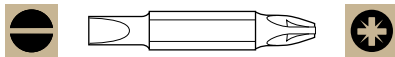

Wersja Classic XH	S0,6x4,5	Pz1	60	222222	10	1	4014468063602
	S0,8x5,5	Pz2	60	222223	10	1	4014468063619

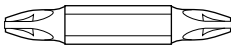
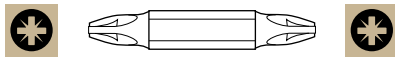

Wersja Classic XH	Pz2	Pz2	60	222217	10	1	4014468063558
-------------------	-----	-----	----	--------	----	---	---------------

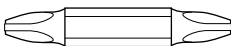
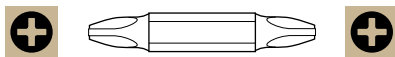

Wersja Classic XH	Ph2	Ph2	60	222219	10	1	4014468063572
-------------------	-----	-----	----	--------	----	---	---------------

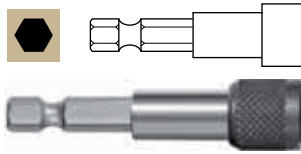

Napęd (cale)	Długość całkowita mm	Średnica mm	Nr katalogowy F00Y...	Zawartość opakowania	Opakowanie wysyłkowe	Kod kreskowy
--------------	----------------------	-------------	-----------------------	----------------------	----------------------	--------------

Uchwyt szybkozmienny z magnesem

1/4"	59	14	232256	1	2	4014468071539
1/4"	75	14	265025	1	2	3165140424271

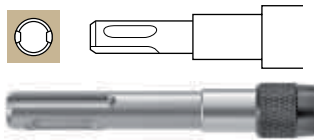

Uchwyt szybkozmienny z magnesem, wersja SDS-plus

SDS-plus	79	14	232255	1	1	4014468071522
----------	----	----	--------	---	---	---------------

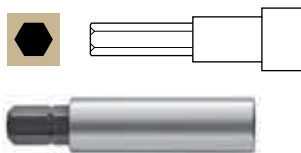

Uchwyt z magnesem ISO 1173 C6.3

1/4"	45	10	232236	1	5	4014468071324
------	----	----	--------	---	---	---------------

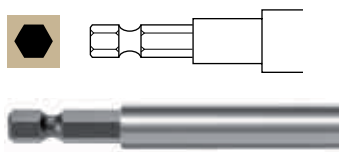

Uchwyt z magnesem ISO 1173 E6.3

1/4"	54	9.5	232227	1	5	4014468071232
------	----	-----	--------	---	---	---------------

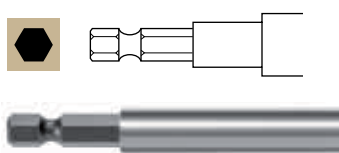

Uchwyt z magnesem i C-Ringiem ISO 1173 E6.3

1/4"	54	9.5	232237	1	5	4014468071331
1/4"	75	10	232234	1	5	4014468071300
1/4"	75	11	232253	1	5	4014468071508
1/4"	102	10	232242	1	1	4014468071386
1/4"	127	10	232244	1	1	4014468071409
1/4"	152	10	232245	1	1	4014468071416
1/4"	279	10	232246	1	1	4014468071423

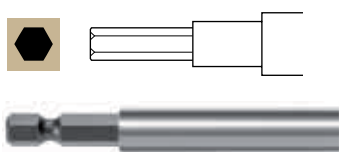

Uchwyt bez magnesu, z C-Ringiem ISO 1173 E6.3

1/4"	54	11	232235	1	5	4014468071317
------	----	----	--------	---	---	---------------

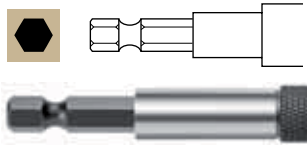

Napęd (cale)	Długość całkowita mm	Średnica mm	Nr katalogowy F00Y...	Zawartość opakowania	Opakowanie wysyłkowe	Kod kreskowy
--------------	----------------------	-------------	-----------------------	----------------------	----------------------	--------------

Uchwyt z magnesem, nasadką gwintowaną i O-Ringiem ISO 1173 E6.3

1/4"	60	10	232239	1	2	4014468071355
1/4"	75	10	232238	1	2	4014468071348
1/4"	125	10	232241	1	2	4014468071379
1/4"	150	10	232243	1	2	4014468071393

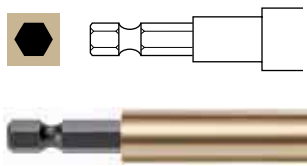

Uchwyt z magnesem i C-Ringiem, brąz krzemowy zapobiega powstawaniu iskier ISO 1173 E6.3

1/4"	75	11	232249	1	2	4014468071454
------	----	----	--------	---	---	---------------

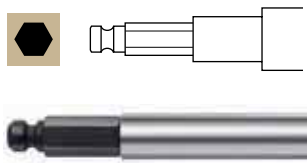

Uchwyt z magnesem, wersja Desoutter 5/16"

5/16"	75	10	232250	1	1	4014468071478
-------	----	----	--------	---	---	---------------

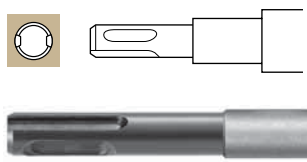

Uchwyt z magnesem i C-Ringiem, wersja SDS-plus

SDS-plus	98	11	232247	1	1	4014468071430
----------	----	----	--------	---	---	---------------

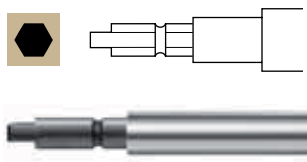

Uchwyt z magnesem i C-Ringiem, wersja ISO 1173 G7

G7	75	9.5	232248	1	1	4014468071447
----	----	-----	--------	---	---	---------------

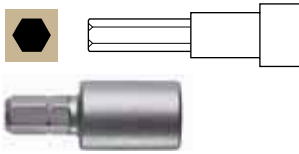

Szer. mm	Szerokość cała	Długość mm	Nr katalogowy F00Y...	Zawartość opakowania	Opakowanie wysyłkowe	Kod kreskowy
----------	----------------	------------	-----------------------	----------------------	----------------------	--------------

Wkładki do kluczy nasadowych z magnesem ISO 1173 C6.3, chwyt zewnętrzny sześciokątny 1/4"

7		32	232218	1	5	4014468071140
8		32	232219	1	5	4014468071157
10		32	232220	1	5	4014468071164
	1 / 4 "	32	232214	1	5	4014468071102
	5/16"	32	232215	1	5	4014468071119
	3 / 8 "	32	232216	1	5	4014468071126

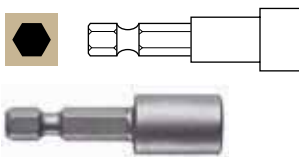

Wkładki do kluczy nasadowych z magnesem ISO 1173 C6.3, chwyt zewnętrzny sześciokątny 1/4"

6		41	232208	1	5	4014468071041
5.5		45	232222	1	5	4014468071188
7		45	232217	1	5	4014468071133
8		45	232209	1	5	4014468071058
10		45	232210	1	5	4014468071065
	1 / 4 "	45	232167	1	5	4014468070631
	5/16"	45	232168	1	5	4014468070648
	3 / 8 "	45	232179	1	5	4014468070754

5.5		65	232158	1	5	4014468070549
6		65	232159	1	5	4014468070556
7		65	232160	1	5	4014468070563
8		65	232161	1	5	4014468070570
10		65	232162	1	5	4014468070587
12		65	232228	1	5	4014468071249
13		65	232229	1	5	4014468071256
	1 / 4 "	65	232155	1	5	4014468070518
	5/16"	65	232156	1	5	4014468070525
	3 / 8 "	65	232157	1	5	4014468070532
	7/16"	65	232213	1	5	4014468071096

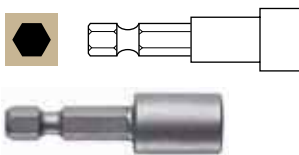

Wkładki do kluczy nasadowych bez magnesu ISO 1173 E6.3, chwyt zewnętrzny sześciokątny 1/4"

7		45	232176	1	5	4014468070723
8		45	232177	1	5	4014468070730
10		45	232178	1	5	4014468070747

7		65	232224	1	5	4014468071201
8		65	232225	1	5	4014468071218
10		65	232226	1	5	4014468071225
12		65	232230	1	5	4014468071263
13		65	232231	1	5	4014468071270

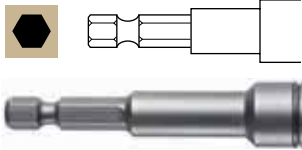

Szer. mm	Szerokość cale	Długość mm	Nr katalogowy F00Y...	Zawartość opakowania	Opakowanie wysyłkowe	Kod kreskowy
----------	----------------	------------	-----------------------	----------------------	----------------------	--------------

Wkładki do kluczy nasadowych ze sprężyną ISO 1173 E6.3, chwyt zewnętrzny sześciokątny 1/4"

8		65	232232	1	5	4014468071287
	3 / 8 "	65	232233	1	5	4014468071294

Klucze nasadowe



Długość mm	Szer. mm	Szerokość cale	Średnica zewnętrzna	Nr katalogowy F00Y...	Zawartość opakowania	Opakowanie wysyłkowe	Kod kreskowy
------------	----------	----------------	---------------------	-----------------------	----------------------	----------------------	--------------

Klucz nasadowy prosty z magnesem, chwyt wewnętrzny czworokątny 1/4"

25	7		11.2	232185	1	3	4014468071003
25	8		12.2	232186	1	3	4014468070822
25	9		13.6	232187	1	3	4014468070839
25	10		14.1	232188	1	3	4014468070846
25	11		16.0	232189	1	3	4014468070853
25	12		17.3	232190	1	3	4014468070860
25	13		18.5	232191	1	3	4014468070877
25		1 / 4 "	11.2	232212	1	3	4014468071089
25		3 / 8 "	14.1	265253	1	3	3165140522007
25		5 / 16 "	12.2	232166	1	3	4014468070624



Klucz nasadowy prosty bez magnesu, chwyt wewnętrzny czworokątny 1/4"

25	7		11.2	232197	1	3	4014468070938
25	8		12.2	232198	1	3	4014468070945
25	9		13.6	232199	1	3	4014468070952
25	10		14.1	232200	1	3	4014468070969
25	11		16.0	232201	1	3	4014468070976
25	12		17.3	232202	1	3	4014468070983
25	13		18.5	232203	1	3	4014468070990
25		1 / 4 "	11.2	232211	1	3	4014468071072
25		3 / 8 "	14.1	265254	1	3	3165140522014
25		5 / 16 "	12.2	232165	1	3	4014468070617

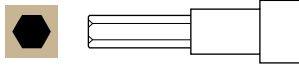

Końcówka	Długość mm	Nr katalogowy F00Y...	Zawartość opakowania	Opakowanie wysyłkowe	Kod kreskowy
----------	------------	-----------------------	----------------------	----------------------	--------------

Przedłużki, napęd wewnętrzny czworokątny ISO 1173-C6.3, 1/4" z zabezpieczeniem walcowym

1/4"	25	232204	1	5	4014468071003
------	----	--------	---	---	---------------

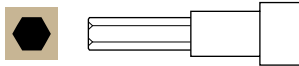

Przedłużki, napęd wewnętrzny czworokątny ISO 1173-C6.3, 1/4" z zabezpieczeniem kulkowym

1/4"	25	232221	1	5	4014468071171
------	----	--------	---	---	---------------

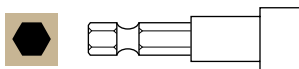

Przedłużki, napęd wewnętrzny czworokątny ISO 1173-E6.3, 1/4" z zabezpieczeniem walcowym

1/4"	50	232174	1	5	4014468070709
1/4"	75	232205	1	5	4014468071010
1/4"	100	232169	1	5	4014468070655
1/4"	150	232170	1	5	4014468070662
1/4"	200	232206	1	5	4014468071027
3/8"	50	232175	1	5	4014468070716
3/8"	75	232207	1	5	4014468071034

Przedłużki, napęd wewnętrzny czworokątny ISO 1173-E6.3, 1/4" z zabezpieczeniem kulkowym

1/4"	50	232223	1	5	4014468071195
------	----	--------	---	---	---------------

Wkrętaki



Wkrętaki z uchwytem magnetycznym

1/4"	65.5	265022	1	2	3165140424240
------	------	--------	---	---	---------------



Wkrętaki z uchwytem magnetycznym

1/4"	190	265021	1	2	3165140424233
1/4"	280	265023	1	2	3165140424257

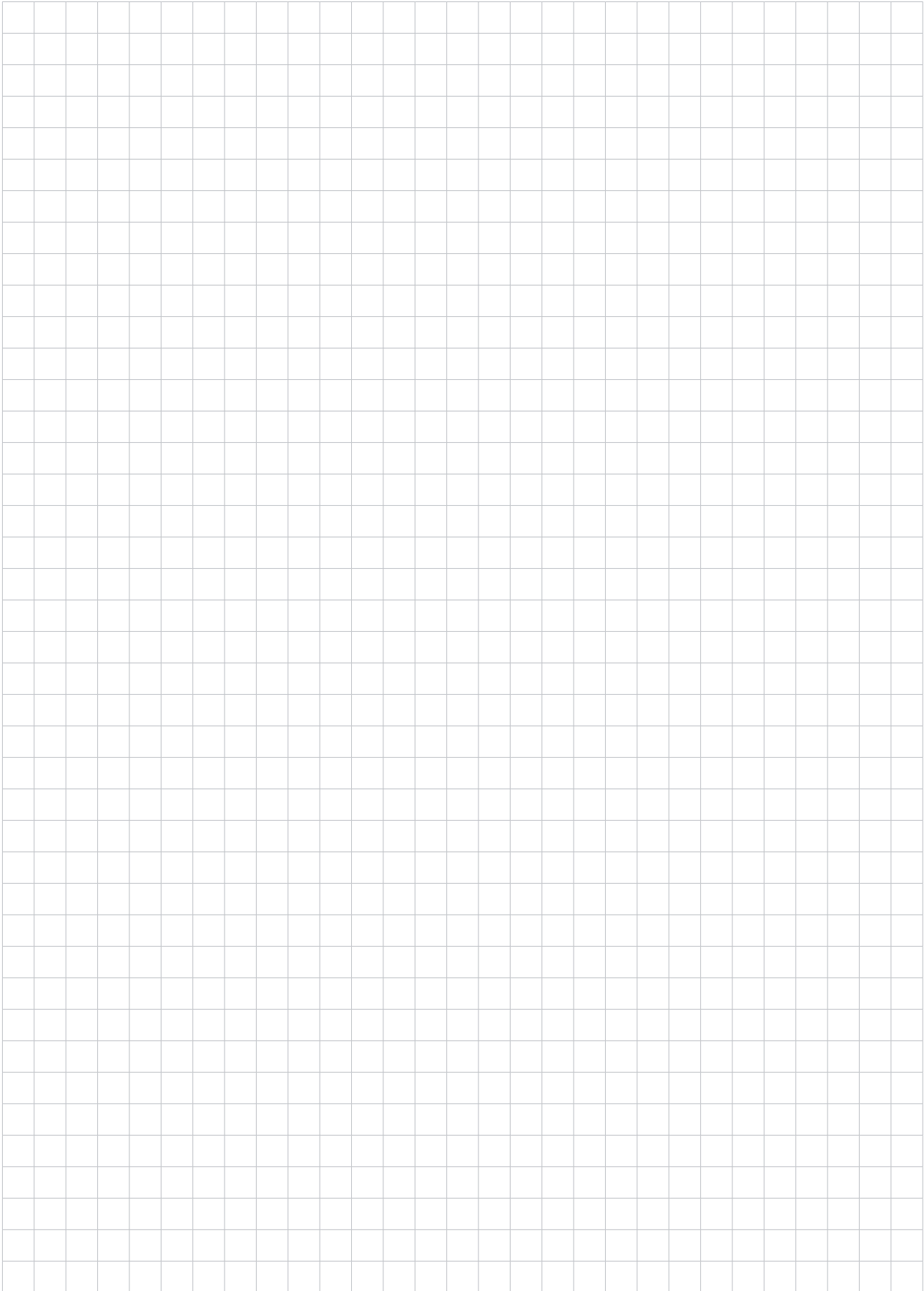

Partner Handlowy:

MAGNA™

Industrial Performance

Scintilla AG
CH-4501 Solothurn
Szwajcaria
www.magna-ind.de

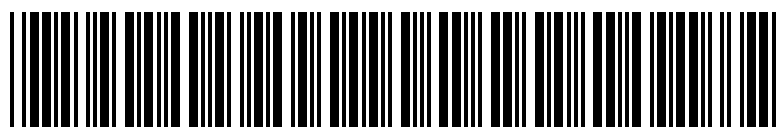

<

1 6 1 9 H 0 0 0 9 M

>